

# FICHA DE REPARACIÓN / REPAIR SHEET

	MODELO / MODEL: <b>F-990RF</b>	TRAZABILIDAD INICIO:
		TRAZABILIDAD FIN:

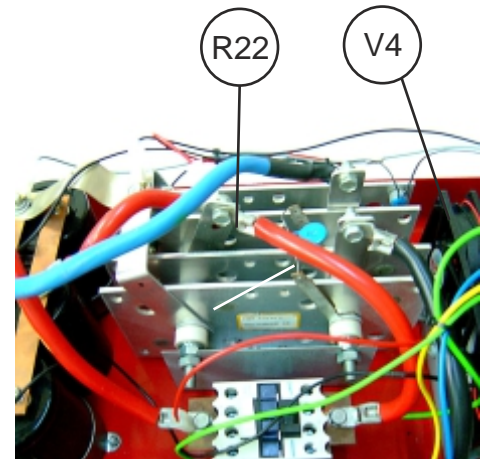

T990

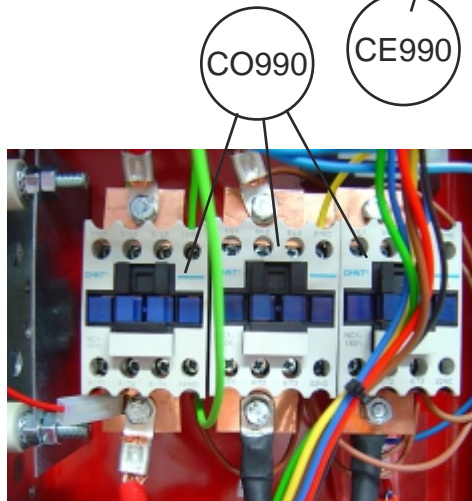
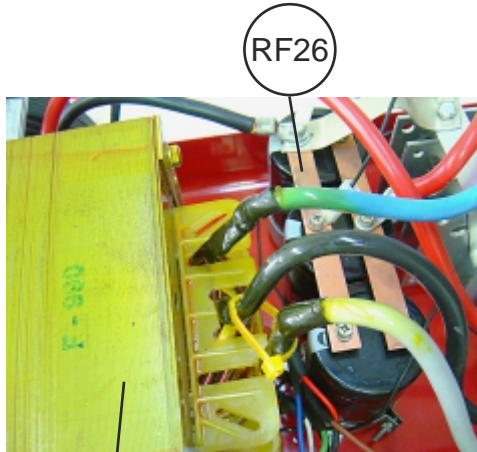
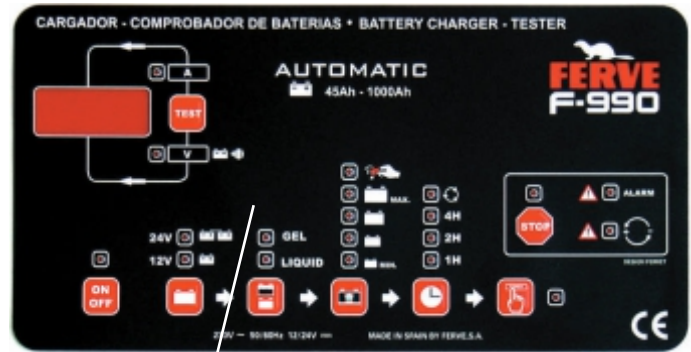
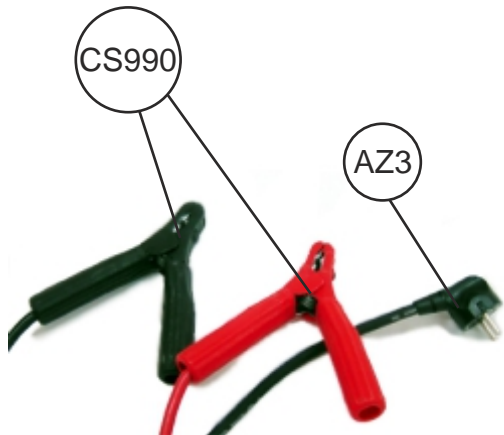
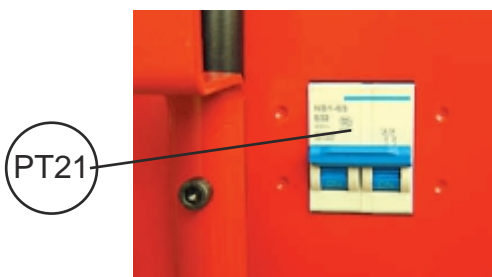

TCE9

Circuitos electrónicos <i>Electronic circuits</i>		Selector <i>Selector</i>	Cable de entrada <i>Input cable</i>	Cable de salida <i>Output cable</i>
CE990	RF26	CO990	AZ3	CS990
Protector <i>Protector</i>	Rectificador <i>Rectifier</i>	Transformadores <i>Transformers</i>		Ventilador <i>Fan</i>
PT21	R22	T990	TCE9	V4

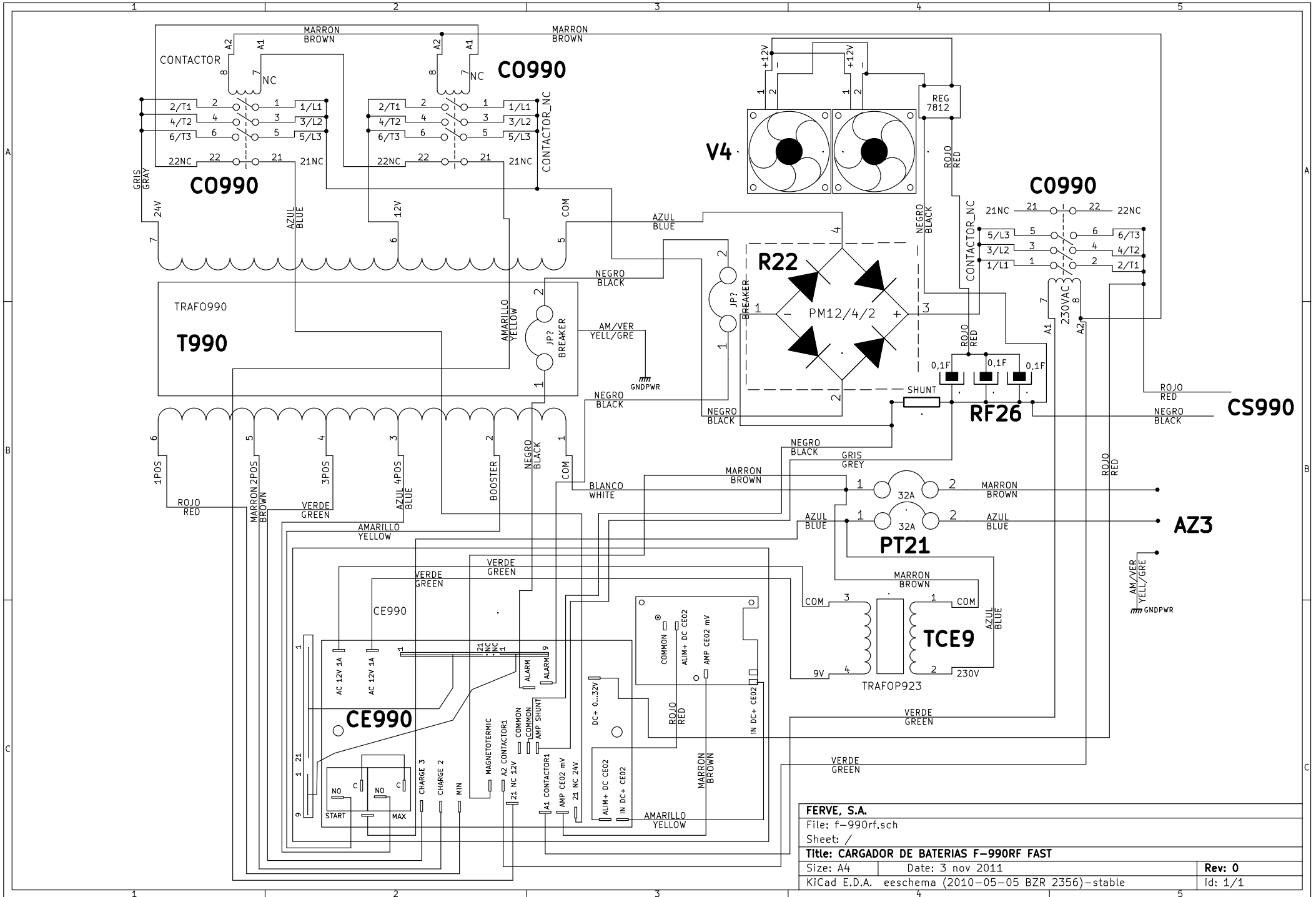

**FERVE, S.A.**  
 File: f-990rf.sch  
 Sheet: /  
**Title: CARGADOR DE BATERIAS F-990RF FAST**  
 Size: A4 Date: 3 nov 2011  
 KiCad E.D.A. eeschema (2010-05-05 BZR 2356)-stable  
**Rev: 0**  
 Id: 1/1